



LIVE THE BRAAI LIFE









GRILLO CHEF 40

MODEL No: 5650









28/37/50 mbar



ASSEMBLY INSTRUCTIONS

| | | | | | |
|---|---|-----|---|---|-----|
| 1 |  | x 1 | 6 |  | x 1 |
| 2 |  | x 3 | 7 |  | x 1 |
| 3 |  | x 1 | 8 |  | x 1 |
| 4 |  | x 1 | | | |
| 5 |  | x 1 | | | |

Accessories

| Item | Spare No. | Item | Spare No. | Item | Spare No. |
|---|------------|---|-----------|---|-----------|
|  | 8600-220 |  | 8600-210 |  | 8600-200 |
|  | 5610-200 |  | |  | 8600-100 |
|  | 5650-SP003 |  | 8610-300 |  | 98368 |

1.

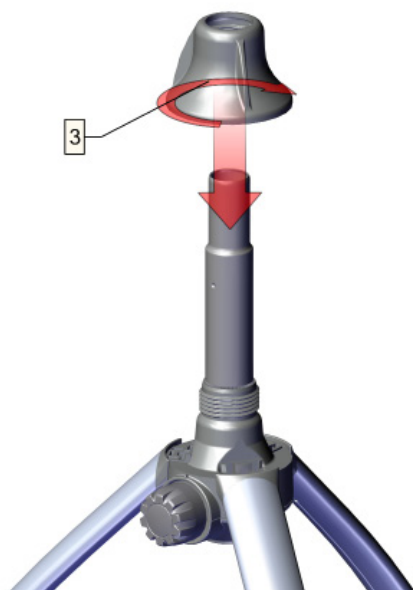
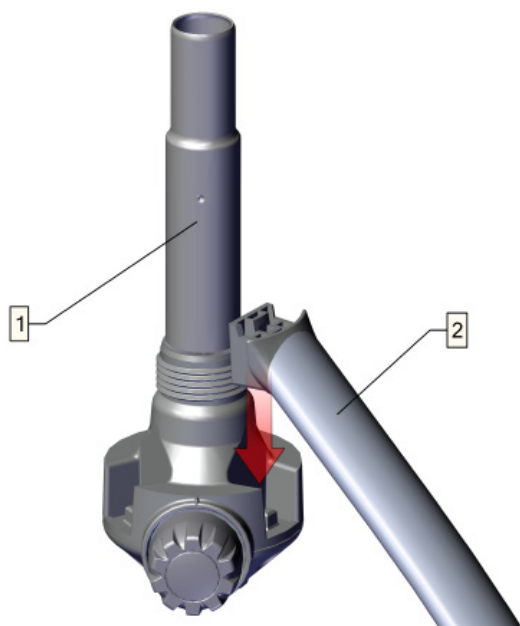



2.

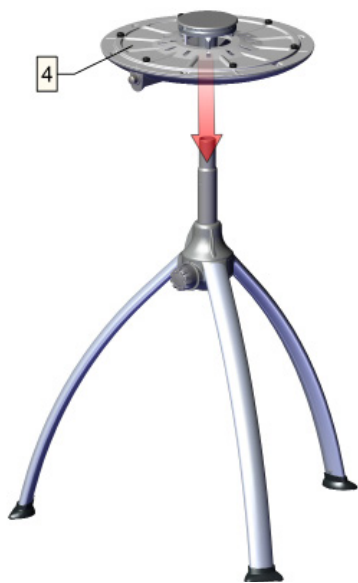

3.

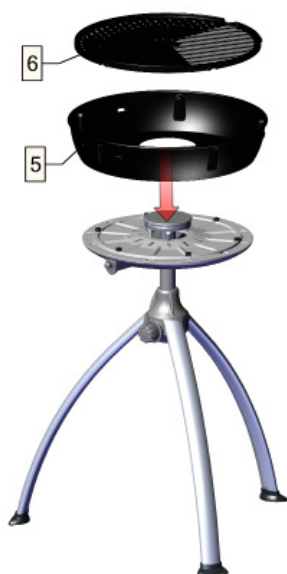

4.



5.

